

**PASSION WEEK**  
PACKET

**GOOD DAY,**

This is a packet for our beloved, elementary students (1st-6th) to keep up during the passion week. It is our prayer that kids to be spiritually fed and to learn about the times that led up to Jesus' crucifixion and resurrection. Although we are not able to meet at church, we pray that kids will continue to grow in wisdom and in God's favor as they mediate on His Word this week.

The online Passion Week service will be held on Mon, Wed, and Fri, which can be found at [www.bkc.org](http://www.bkc.org).

On Tues and Thurs, we encourage kids to read the Bible, which is written in the "To Do List". Please email or message us if you have any questions!

**BLESSINGS,**  
**BETHEL ELEMENTARY DEPT**

# Passion Week to do list

*Do and check off your list and receive talents!. At the end of this week, take a picture of this list and send it to your teacher.*

**MON**  
**4/6/20**

## **Jesus Cleanses the Temple**

Matthew 21:12-17

- have online worship service

**parent  
signature**

**TUE**  
**4/7/20**

## **The Greatest Commandment**

read: Matthew 22:34-40 

- worksheet

**parent  
signature**

**WED**  
**4/8/20**

## **The Last Supper**

Matthew 26:26-29

- have online worship service

**parent  
signature**

**THURS**  
**4/9/20**

## **Jesus Prays in Gethsemane**

read: Matthew 26:36-46 

- worksheet

**parent  
signature**

**FRI**  
**4/10/20**

## **The Cross**

Matthew 27:45-54

- have online worship service

**parent  
signature**

**Dear Jesus,**

**Thank you for dying on the cross for me.**

**I am a child of God because you died on the cross for my sins. I have eternal life not because I deserved it or earned it but because you gave your life.**

**I am so thankful for who you are and what you have done for me.**

**I want to remember this passion week, the love and the suffering that you endured. You walked the life of faith and obedience to the Father. Help me to think about the pain and the death that you endured.**

**You loved me so much that you gave your life for me.**

**I now give you this week in remembrance of your love. I will meditate on the Word of God. I will love you more than anything in this world. You said, "I am the resurrection and the life. The one who believes in me will live, even though they die." May I trust in you and follow you all the days of my life.**

**In Jesus Name I pray,  
Amen**



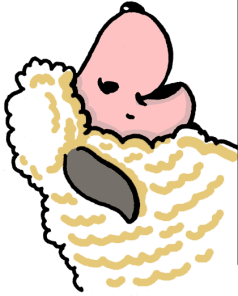

Then what did Jesus say to the Pharisees?

Add and subtract words or letters for the answers. Write the answers in order on the blanks below.



- MB + \_\_\_\_\_ = \_\_\_\_\_



- HEEL = \_\_\_\_\_



- EA + \_\_\_\_\_ = \_\_\_\_\_



- M + \_\_\_\_\_ = \_\_\_\_\_



- AR + \_\_\_\_\_ = \_\_\_\_\_



- UN \_\_\_\_\_



- D + \_\_\_\_\_ = \_\_\_\_\_



- DO = \_\_\_\_\_



- REE + \_\_\_\_\_ = \_\_\_\_\_



- AGN = \_\_\_\_\_

Jesus said, "All the \_\_\_\_\_ and the \_\_\_\_\_ on these \_\_\_\_\_ commandments."

# Children's Worship Bulletin™



Ages 7+

April 7, 2020 • Matthew 22:34-40

## The Greatest Commandment

One of the Pharisees, an expert in the law, tested Jesus with this question: "Teacher, which is the greatest commandment in the Law?"

Find the 10 commandment tablets of stone \_\_\_\_\_ in the picture.

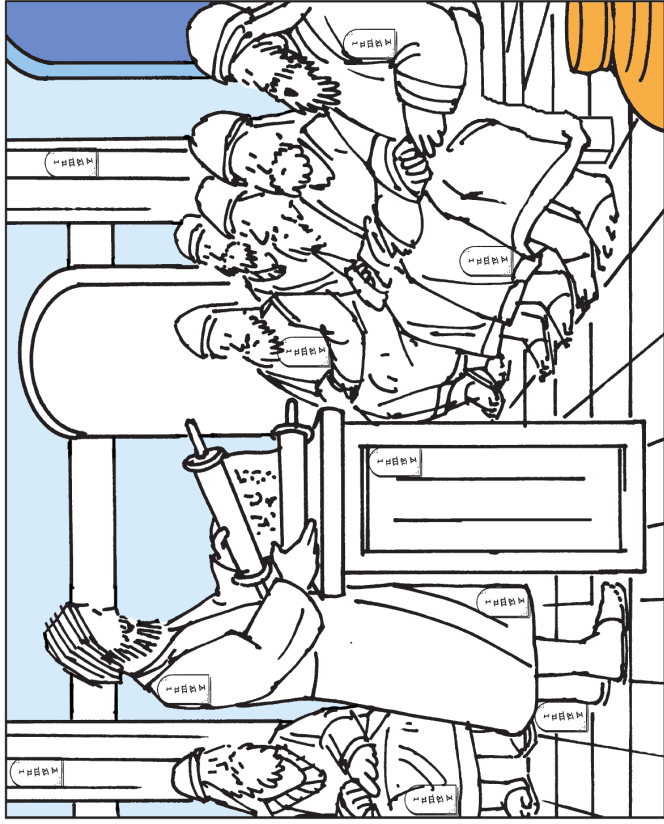





Jesus cried out and then He breathed His last breath. What happened next?

Find these words in the word search and then fill in the blanks.

- |     |     |       |       |        |           |
|-----|-----|-------|-------|--------|-----------|
| two | saw | died  | when  | heard  | temple    |
| top | son | torn  | front | Jesus  | bottom    |
| cry | man | stood | there | surely | centurion |

H	V	O	E	U	S	U	R	E	L	Y	E	X
T	W	O	M	O	R	R	A	A	W	F	Y	T
O	D	Y	T	H	N	V	L	A	T	O	P	C
R	W	F	S	U	Q	G	S	T	O	O	D	C
N	H	W	D	U	M	E	U	X	L	T	V	R
A	E	U	S	T	L	D	R	H	F	E	G	Y
H	N	A	N	P	D	I	H	J	E	S	U	S
O	W	O	M	J	I	E	E	T	N	Y	I	F
W	R	E	R	T	D	A	H	S	J	F	X	Z
F	T	L	N	M	D	W	R	E	J	M	R	Z
B	O	T	O	M	P	D	R	N	U	O	C	
D	Y	M	I	K	A	F	Q	E	B	I	N	I
V	H	W	C	E	N	T	U	R	I	O	N	M

The curtain of the \_\_\_\_\_ was \_\_\_\_\_ in \_\_\_\_\_ from \_\_\_\_\_ to \_\_\_\_\_. And \_\_\_\_\_ the \_\_\_\_\_, who \_\_\_\_\_ his \_\_\_\_\_ in \_\_\_\_\_ of \_\_\_\_\_, \_\_\_\_\_ he said, " \_\_\_\_\_ and \_\_\_\_\_ how he \_\_\_\_\_, he said, " \_\_\_\_\_ this \_\_\_\_\_ was the \_\_\_\_\_ of God!"

# Children's Worship Bulletin™



Ages 7+

April 9, 2020 • Mark 15:1-39

## Jesus Before Pilate

Very early in the morning, the religious leaders made a decision about Jesus. Where did they take Him?

Read the story in the maze as you follow where they took Jesus.

“Very early here in the city of Jerusalem, the chief priests and the elders and the scribes gathered together in the morning, and they decided to kill Jesus. They bound Him and handed Him over to Pilate.”



Jesus answered, "Yes, it is as you say."

What happened next? Use the words in the box to fill in the missing words. Then match the story with its picture.

set  
away  
robe  
torn

After  
cross  
crown  
place

Simon  
bottom  
temple  
forced

brought  
passing  
soldiers  
crucified

1 The \_\_\_\_\_ led Jesus  
\_\_\_\_\_ w \_\_\_\_\_. They put a purple \_\_\_\_\_  
on Him, then twisted a \_\_\_\_\_ w \_\_\_\_ of  
thorns and \_\_\_\_\_ it on Him.

2 \_\_\_\_\_ o \_\_\_\_ was  
\_\_\_\_\_ s \_\_\_\_\_ g by, and they  
\_\_\_\_\_ c \_\_\_\_\_ him to carry the  
\_\_\_\_\_.

3 They \_\_\_\_\_ Jesus  
to a \_\_\_\_\_ called Golgotha,  
and there they  
\_\_\_\_\_ Him.

4 \_\_\_\_\_ Jesus died, the curtain of  
the \_\_\_\_\_ l \_\_\_\_\_ was \_\_\_\_\_  
in two from top to \_\_\_\_\_.

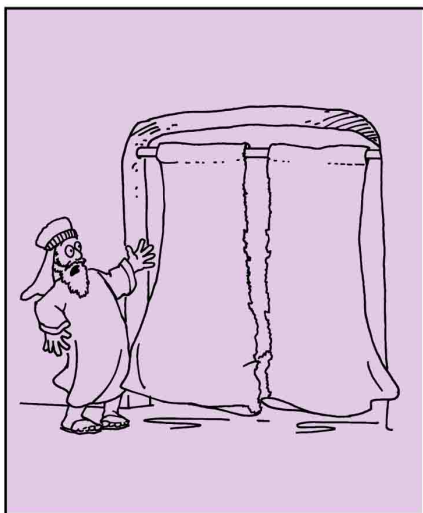

# \_\_\_\_\_

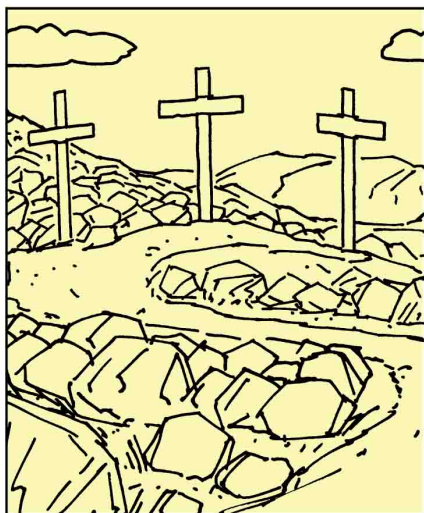

# \_\_\_\_\_

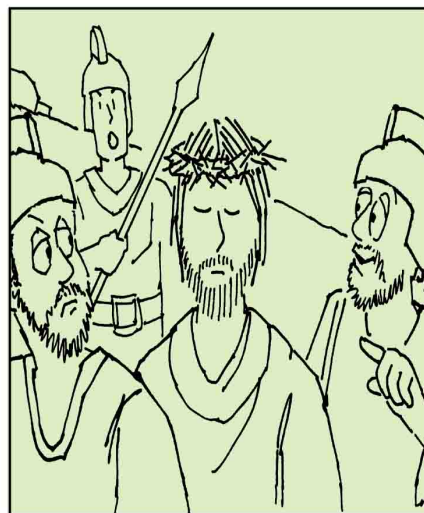

# \_\_\_\_\_



# \_\_\_\_\_

# Answers



Then what did Jesus say to the Pharisees?

Add and subtract words or letters for the answers. Write the answers in order on the blanks below.

- MB + - HEEL = LAW

- EA + - M + - AR + - UN = PROPHETS

- D + - DO = HANG

- REE + - AGN = TWO

Jesus said, "All the law and the prophets hang on these two commandments."

© 2017 CRI • www.ChildrensLit.com • 1-800-982-2144  
Scriptures taken from the Holy Bible, New International Version™, NIV™. Copyright © 1973, 1978, 1984, 2011 by Biblos, Inc.™

Jesus said, "And the second is like it..."

Read the clue and write the word. Use the numbers to fill in the blanks below.



very active busy

device for cooling the air fan

opposite of heavy light

opposite of under over

"... love your neighbor as yourself."

Jesus answered, "Yes, it is as you say."

What happened next? Use the words in the box to fill in the missing words. Then match the story with its picture.

set away robe torn After cross crown place Simon bottom temple forced brought; passing soldiers crucified

① The soldiers led Jesus away. They put a purple robe on Him, then twisted a crown of thorns and set it on Him.

② Simon was passing by, and they forced him to carry the cross.

③ They brought Jesus to a place called Golgotha, and there they crucified Him.

④ After Jesus died, the curtain of the temple was torn in two from top to bottom.



# 4



# 3



# 1



# 2

## The Greatest Commandment

One of the Pharisees, an expert in the law, tested Jesus with this question: "Teacher, which is the greatest commandment in the Law?"

Find the 10 commandment tablets of stone in the picture.

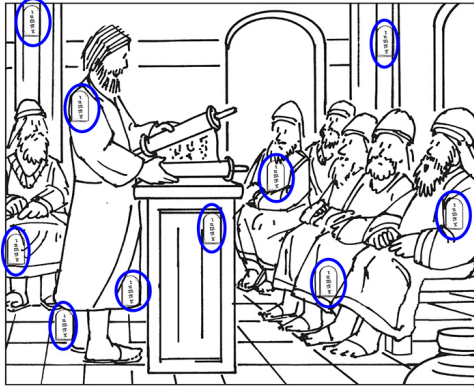

Jesus replied: "Love the Lord your God with all your heart and with all your soul and with all your mind."

Use the heart code to write the letters on the blanks.

♥ = A   ♥ = E   ♥ = I   ♥ = M   ♥ = Q   ♥ = U   ♥ = Y  
♥ = B   ♥ = F   ♥ = J   ♥ = N   ♥ = R   ♥ = V   ♥ = Z  
♥ = C   ♥ = G   ♥ = K   ♥ = O   ♥ = S   ♥ = W  
♥ = D   ♥ = H   ♥ = L   ♥ = P   ♥ = T   ♥ = X



" T h i s i s

t h e f i r s t

a n d

g r e a t e s t

c o m m a n d m e n t ."

## Jesus Before Pilate

Very early in the morning, the religious leaders made a decision about Jesus. Where did they take Him?

Head the maze as you follow where they took Jesus.

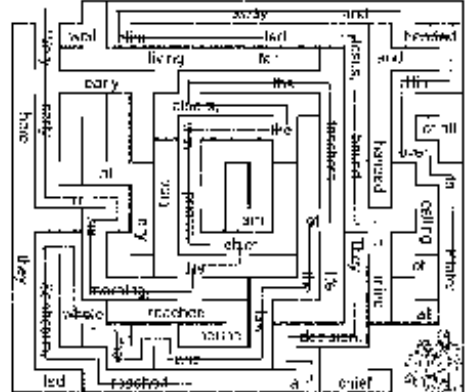

Jesus answered, "Yes, it is as you say."

What happened next? Use the words in the box to fill in the missing words. Then match the story with its picture.

set away robe torn After cross crown place Simon bottom temple forced brought; passing soldiers crucified

① The soldiers led Jesus away. They put a purple robe on Him, then twisted a crown of thorns and set it on Him.

② Simon was passing by, and they forced him to carry the cross.

③ They brought Jesus to a place called Golgotha, and there they crucified Him.

④ After Jesus died, the curtain of the temple was torn in two from top to bottom.



# 4



# 3



# 1



# 2